

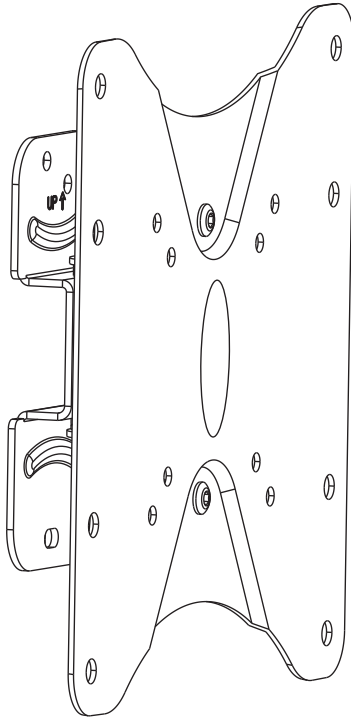

23"-42" FLAT SCREEN TILT/SWIVEL WALL MOUNT BRACKET





650104



75x75/100x100
200x100/200x200



EN  Read the entire instruction manual before you start installation and assembly. If you have any questions regarding any of the instructions or warnings, please contact your local distributor for assistance.

 **CAUTION:** Use with products heavier than the rated weights indicated may result in instability causing possible injury.

- Mounts must be attached as specified in assembly instructions. Improper installation may result in damage or serious personal injury.
- Safety gear and proper tools must be used. This product should only be installed by professionals.
- This product is designed to be installed only on solid concrete walls or brick walls.
- Make sure that the supporting surface will safely support the combined weight of the equipment and all attached hardware and components.
- Use the mounting screws provided and DO NOT OVER TIGHTEN mounting screws
- This product contains small items that could be a choking hazard if swallowed. Keep these items away from children.
- This product is intended for indoor use only. Using this product outdoors could lead to product failure and personal injury.

IMPORTANT: Ensure that you have received all parts according to the component checklist prior to installation. If any parts are missing or faulty, telephone your local distributor for a replacement.

MAINTENANCE: Check that the bracket is secure and safe to use at regular intervals (at least every three months).

GE  Bitte vor Beginn der Montage und Zusammenbau das ganze Handbuch durchlesen. Bitte sich mit dem Händler vor Ort bei Fragen zur Anleitung oder Warnungen in Verbindung setzen.

 **VORSICHT:** Bei Verwendung mit Produkten, die das zulässige Gewicht überschreiten, können Schäden oder möglicherweise Verletzungen die Folge sein.

- Halterungen sollen entsprechend den Montageanweisungen angebracht werden. Eine unsachgemäße Montage kann Schäden oder Verletzungen zur Folge haben.
- Sicherheitsausrüstung und geeignete Werkzeuge verwenden. Die Montage des Produktes sollte nur von Fachleuten durchgeführt werden.
- Dieses Produkt kann nur auf massiven Beton- oder Ziegelwänden montiert werden.
- Die tragenden Oberflächen sollten das gesamte Gewicht von Geräten und allen zusätzlichen Bauteilen sicher aushalten können.
- Nur die mitgelieferten Einbauschrauben verwenden und die Schrauben NICHT ZU FEST ANZIEHEN.
- Dieses Produkt enthält Kleinteile, die Erstickungsgefahr beim Verschlucken hervorrufen können. Diese Teile von Kindern fernhalten.
- Dieses Produkt nur in Innenräumen verwenden. Verwendung des Produktes im Außenbereich kann zu Verletzungen und Schäden führen.

WICHTIG: Vor der Montage bitte alle erhaltenen Bauteile mit der Bauteilliste abgleichen. Bei beschädigten oder fehlenden Teilen den Händler vor Ort nach Ersatzteilen fragen.

WARTUNG: Die Halterungsklammer regelmäßig auf Sicherheit und Stabilität prüfen (am besten alle drei Monate).

FR  Lisez entièrement le guide d'utilisateur avant de commencer l'installation et le montage. Si vous avez des questions concernant les instructions ou les avertissements, veuillez contacter votre distributeur local pour une assistance.

 **ATTENTION:** L'utilisation de produits plus lourds que les poids nominaux indiqués peut entraîner une instabilité causant des blessures potentielles.

- Les supports doivent être joints comme spécifié dans les instructions de montage. Une mauvaise installation peut entraîner des dommages ou de graves blessures aux personnes.
- Un équipement de sécurité et les outils appropriés doivent être utilisés. Ce produit devrait être installé uniquement par des professionnels.
- Ce produit est conçu pour être installé uniquement sur des murs en béton massif ou en brique.
- Assurez-vous que la surface de soutien supporte en sécurité le poids combiné de l'équipement et de tous les matériaux et composants associés.
- Utilisez les vis de montage fournies et NE SERREZ PAS TROP les vis de montage
- Ce produit contient de petites pièces qui peuvent causer un étouffement si elles sont avalées. Éloignez ces pièces des enfants.
- Ce produit est prévu uniquement pour une utilisation à l'intérieur. L'utilisation de ce produit à l'extérieur peut entraîner une défaillance du produit ou des blessures aux personnes.

IMPORTANT: Avant l'installation, assurez-vous que vous avez reçu toutes les pièces selon la liste de vérification des composants. Si une pièce est manquante ou endommagée, téléphonez à votre distributeur local pour qu'il la remplace.

MAINTENANCE: À intervalles réguliers (au moins tous les trois mois) vérifiez que le support est d'utilisation sûre et fiable

RU  Перед началом установки и сборки прочитайте руководство по установке. Если у Вас возникли какие-либо вопросы относительно инструкций или предупреждений, свяжитесь с Вашим локальным распространителем для получения помощи.

 **Внимание:** Использование продуктов, вес которых превышает указанный расчетный вес, может привести к нестабильности и возможным повреждениям.

- Оперы должны быть установлены, как это показано в монтажных инструкциях. Неправильная установка может привести к получению серьезных травм.
- Необходимо использовать предохранительное устройство и специальные инструменты. Продукт должен устанавливаться только профессионалами.
- Продукт предназначен для установки на деревянные каркасные стены, твердые цементные стены или кирпичные стены.
- Убедитесь, что несущая поверхность выдержит вес оборудования и всего установленного оборудования и комплектующих.
- Необходимо использовать идущие в комплекте установочные шурупы и НЕ ПЕРЕТЯГИВАТЬ установочные шурупы
- Данный продукт содержит маленькие детали, которые представляют опасность удушья при проглатывании. Такие детали необходимо хранить в недоступном для детей месте.
- Данный продукт предназначен только для эксплуатации в помещениях. Использование данного продукта на улице может привести к поломке продукта и получению травм.

ВАЖНО: Перед установкой убедитесь, что Вы получили все детали в соответствии со списком комплектующих. Если не хватает каких-либо деталей или они поломаны, свяжитесь с Вашим местным распространителем по вопросу замены.

SP  Lea todo el manual de instrucciones antes de comenzar la instalación y ensamble de la unidad. Si tiene alguna inquietud con respecto a las instrucciones o advertencias, comuníquese con su distribuidor local.

 **PRECAUCIÓN:** utilizar con productos de mayor peso al indicado en los límites de peso podría ocasionar inestabilidad y posibles heridas personales.

- Los soportes deben acoplarse tal como se indica en las instrucciones de ensamble. Una incorrecta instalación podría ocasionar daños y serias heridas personales.
- Utilice las herramientas y equipo de seguridad adecuados. Este producto solo debe ser instalado por profesionales.
- Este producto está diseñado únicamente para instalaciones en paredes de concreto o bloques.
- Asegúrese de que la superficie de fijación sostenga de manera segura el peso total del equipo y todos sus componentes y hardware.
- Utilice los tornillos de ensamble suministrados y NO aplique demasiada tensión a los tornillos.
- Este producto contiene piezas pequeñas que representan un riesgo de asfixia. Mantenga estas piezas fuera del alcance de los niños.
- Este producto está diseñado para uso en interiores solamente. Utilizar este producto en exteriores podría ocasionar fallas y heridas personales.

IMPORTANTE: Asegúrese de que haya recibido todas las piezas según la lista de verificación de componentes para la instalación. Si falta alguna de las partes, o está dañada, comuníquese con su distribuidor.

MANTENIMIENTO: Compruebe periódicamente que el soporte esté asegurado y listo para usar (al menos cada tres meses).

POR  Leia todo o manual de instruções antes de iniciar a instalação e montagem. Se você tiver alguma dúvida sobre quaisquer uma das instruções ou avisos, por favor, entre em contato com o seu distribuidor local para assistência.

 **ATENÇÃO:** O uso com produtos mais pesados do que os pesos indicados pode resultar em instabilidade, causando possíveis danos.

- Os suportes devem ser anexados como especificado nas instruções de montagem. A instalação incorreta pode causar danos ou sérias lesões pessoais.
- Equipamentos de segurança e ferramentas adequadas devem ser utilizadas. Este produto só deve ser instalado por profissionais.
- Este produto é projetado para ser instalado somente em paredes de concreto sólido ou de tijolos.
- Certifique-se que a superfície de suporte suportará com segurança o peso combinado do equipamento e todas as ferragens e componentes anexados.
- Use os parafusos de montagem fornecidos e NÃO APERTE EXCESSIVAMENTE os mesmos.
- Este produto contém pequenas peças que podem causar asfixia se ingeridas. Mantenha esses itens longe do alcance de crianças.
- Este produto destina-se somente para uso interno. Usá-lo em ambiente externo pode causar falhas no produto e lesões pessoais.

IMPORTANTE: Asegure-se que você recebeu todas as peças, de acordo com a lista de componentes, antes da instalação. Se alguma peça estiver faltando ou é defeituosa, contate o seu distribuidor local para substituição.

MANUTENÇÃO: Certifique-se que o suporte seja seguro e protegido para o uso em intervalos regulares (pelo menos a cada três meses).

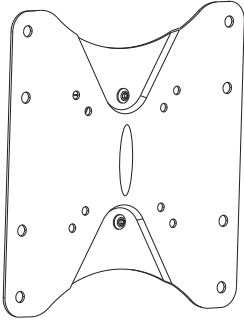

VESA plate (x1)
A

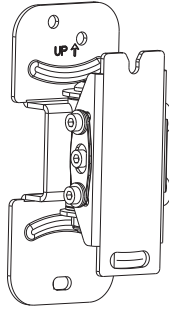

wall plate (x1)
B

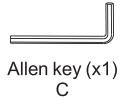

Allen key (x1)
C



wrench (x1)
D



M4x14 (x4)
M-A



M5x14 (x4)
M-B

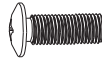

M6x14 (x4)
M-C



M8x20 (x4)
M-D



D5 washer (x4)
M-E



D8 washer (x4)
M-F



small spacer (x8)
M-G

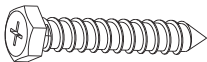

ST6.3x55 (x3)
W-A

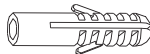

concrete anchor (x3)
W-B



D6 washer (x3)
W-C

1.

1-1

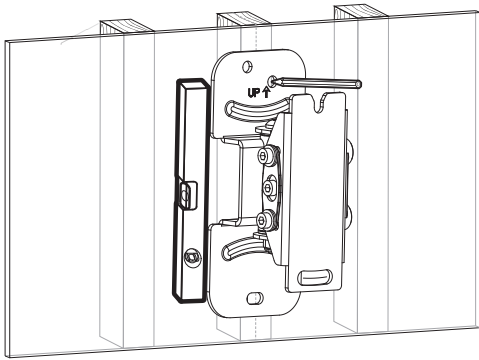
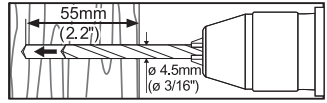
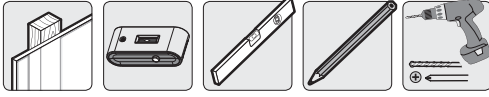

Find and mark the exact location of mounting holes

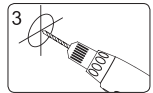
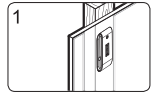

Drill pilot holes

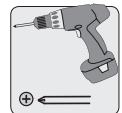
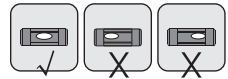
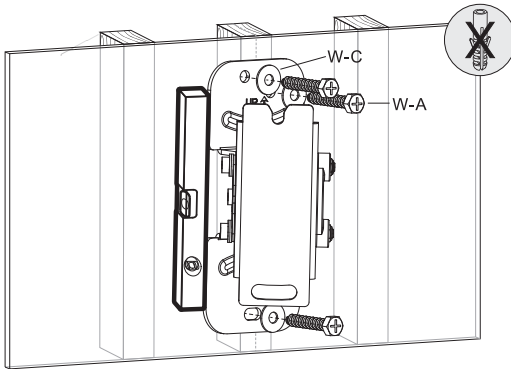

Screw the wall plate onto the wall

with the arrow pointing up.

1.

1-2

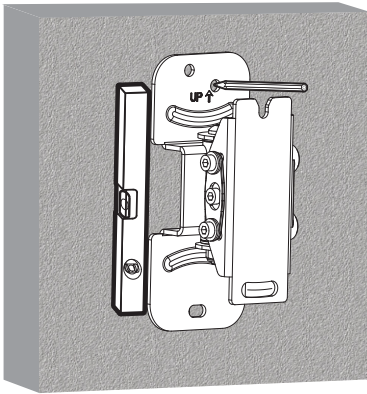
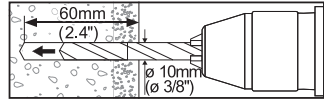
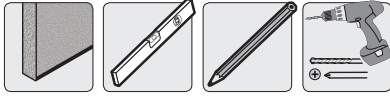

Mark the exact location of mounting holes

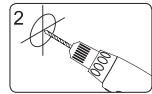

Drill pilot holes

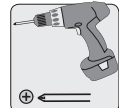
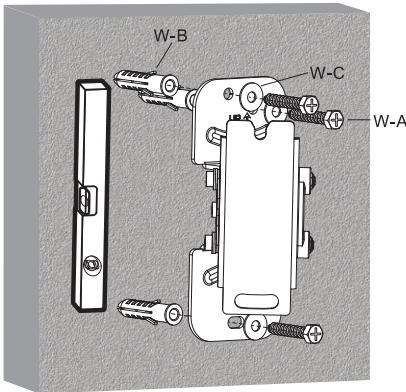
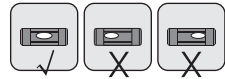

Screw the wall plate onto the wall

with the arrow pointing up.

2.

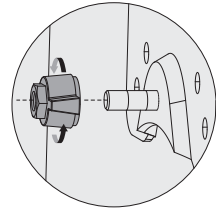
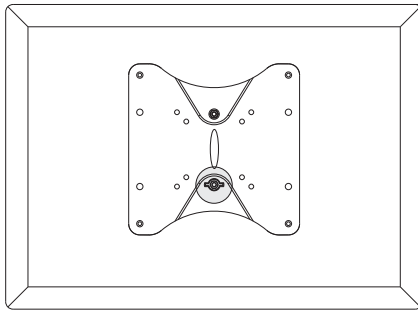

Remove the plastic knob.

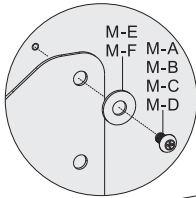
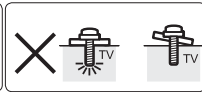
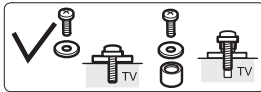

or

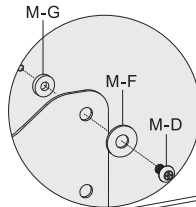

or

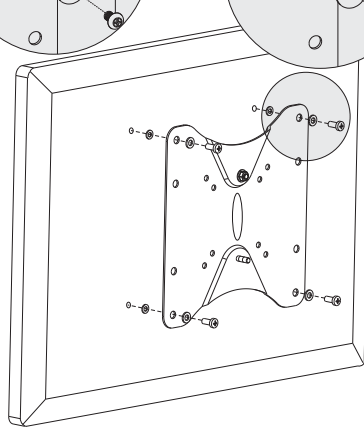
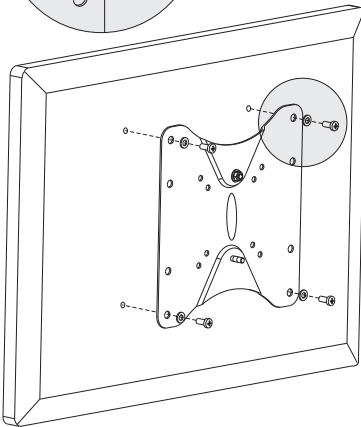
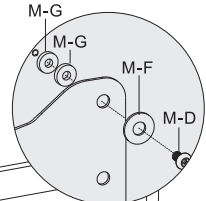

3.

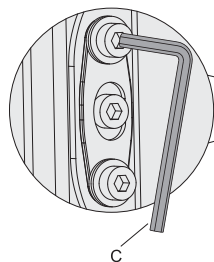
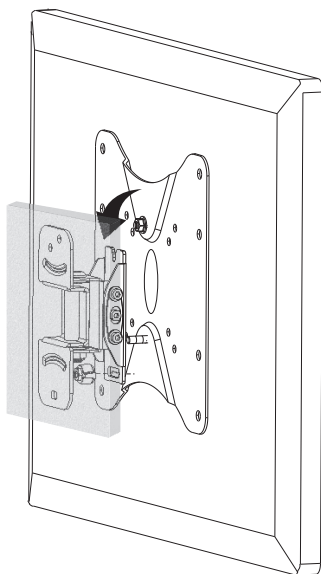

Tension is already pre-set at the factory. If it's too tight or too loose, you may adjust the tension by loosening or tightening the adjustment bolts.

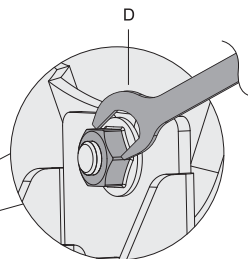

Place the plastic knob and tighten the upper nut and the lower plastic knob.

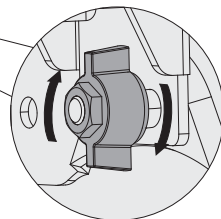

4.

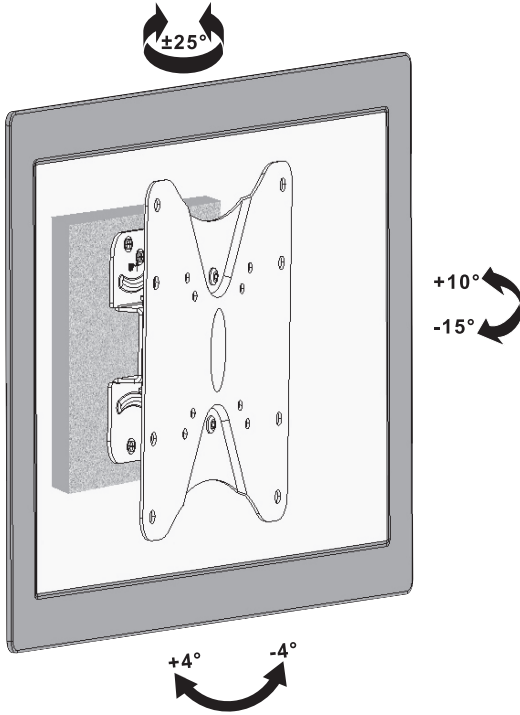

Adjust to the desired position or tilt.